



**ASSTRA**  
ASSOCIATED TRAFFIC AG



**LOGISTICS**  
**GUIDE**

# LOGISTICS GUIDE

INCOTERMS 2010

COUNTRY, CURRENCY & PHONE CODES

DISTANCES IN KM

TABLES OF METRIC WEIGHTS & MEASURES

TYPES OF VEHICLES AND EQUIPMENT

TYPES OF RAILWAY ROLLING STOCK

TYPES OF CONTAINERS

ULD'S SPECIFICATION

HAZARD CLASSIFICATIONS (ADR)

TYPES OF PALLETS

Samples of Useful Documents

- CMR Consignment
- AIR WAYBILL
- Bill of Lading
- FBL (Negotiable Fiata Multimodal Transport Bill of Lading)
- FIATA FCR (Forwarders Certificate of Receipt)

- SMGS Railway Bill
- CIM Railway Bill
- CIM SMGS Railway Bill
- Carnet TIR
- Carnet ATA



# INCOTERMS 2010

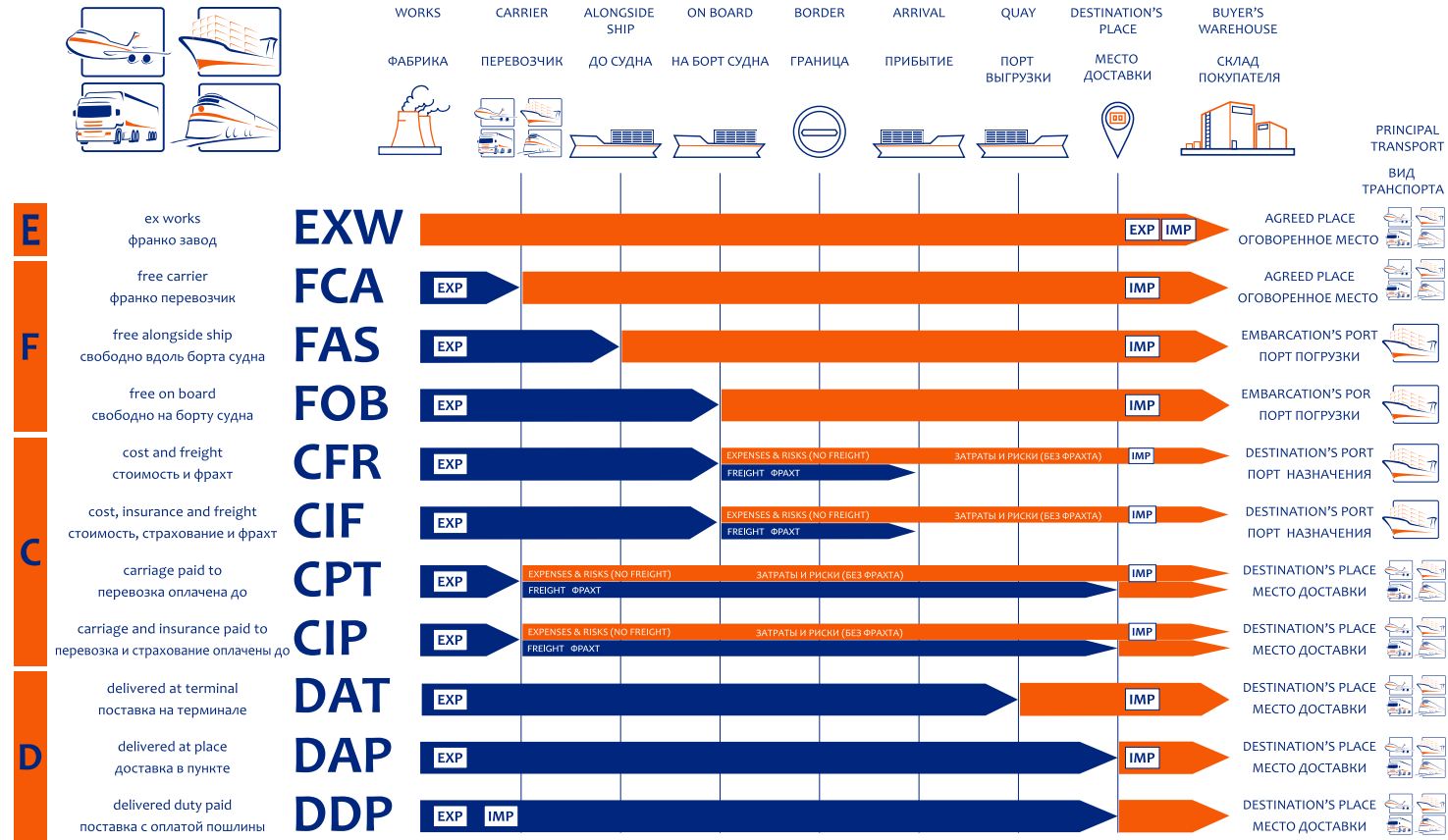

- BASIC GROUPS / ОСНОВНЫЕ КАТЕГОРИИ**
- E EX WORKS** - ВЫВОЗ С ПРОИЗВОДСТВА
  - F FREE** - ОПЛАЧЕНО
  - C CARRIAGE** - ПЕРЕВОЗКА
  - D DELIVERED** - ДОСТАВКА
  - EXP EXPORT CLEARANCE** - ЭКСПОРТНОЕ ТАМОЖЕННОЕ ОФОРМЛЕНИЕ
  - IMP IMPORT CLEARANCE** - ИМПОРТНОЕ ТАМОЖЕННОЕ ОФОРМЛЕНИЕ

**ASSTRA**  
ASSOCIATED TRAFFIC AG

SELLER - ПОСТАВЩИК      BUYER - ПОЛУЧАТЕЛЬ

EXPENSES & RISKS  
ЗАТРАТЫ И РИСКИ

ENJOY  
YOUR LOGISTICS!

# COUNTRY, CURRENCY & PHONE CODES

COUNTRY	ALPHA-2 CODE	ALPHA-2 CODE	CURRENCY	PHONE CODE
Albania	AL	ALB	ALL Albanian lek	355+ Tirana 42
Armenia	AM	ARM	AMD Dram	374+ Yerevan 2
Australia	AU	AUS	AUD Australian dollar	61+ Canberra 2
Austria	AT	AUT	EUR Euro	43+ Vienna 1
Azerbaijan	AZ	AZE	AZM Manat	994+ Baku 12
Belarus	BY	BLR	BYN Belarusian ruble	375+ Minsk 17
Belgium	BE	BEL	EUR Euro	32+ Brussels 2
Brazil	BR	BRA	BRL Real	55+ Brasilia 61
Canada	CA	CAN	CAD Canadian dollar	1+ Ottawa 613
China	CN	CHN	CNY Yuan	86+ Pekin 10
Cyprus	CY	CYP	EUR Euro	357+ Nikozja
Czech Republic	CZ	CZE	CZK Czech koruna	420+ Prague 2
Denmark	DK	DNK	DKK Danish krone	45+ Copenhagen
Estonia	EE	EST	EEK Estonian kroon	372+ Tallinn 2
Finland	FI	FIN	EUR Euro	358+ Helsinki 9
France	FR	FRA	EUR Euro	33+ Paris 1
Georgia	GE	GEO	GEL Lari	995+ Tbilisi 32
Germany	DE	DEU	EUR Euro	49+ Berlin 30
Greece	GR	GRC	EUR Euro	30+ Athens 1
Hungary	HU	HUN	HUF Forint	36+ Budapest 1
India	IN	IND	INR Indian rupee	91+ New Delhi 11
Israel	IL	ISR	ILS Israeli new sheqel	972+ Jerusalem 2
Italy	IT	ITA	EUR Euro	39+ Rome 06
Iran	IR	IRN	IRR Rial	98+ Tehran 021
Ireland	IE	IRL	EUR Euro	353+ Dublin 353 (0) 1
Japan	JP	JPN	JPY Yen	81+ Tokyo 3
Kazakhstan	KZ	KAZ	KZT Tenge	7+ Almaty 3272
Kyrgyzstan	KG	KGZ	KGS Som	996+ Bishkek 312
Latvia	LV	LVA	EUR Euro	371+ Riga 2
Lithuania	LT	LTA	EUR Euro	370+ Vilnius 5
Luxembourg	LU	LUX	EUR Euro	352+ Luxembourg
Moldova	MD	MDA	MDL Moldavian lei	373+ Chisinau 22
Netherlands	NL	NLD	EUR Euro	31+ Amsterdam 20
Norway	NO	NOR	NOK Norwegian krona	47+ Oslo 2
Poland	PL	POL	PLN Zloty	48+ Warsaw 22
Romania	RO	ROU	RON Romanian leu	40+ Bucharest 1
Russian Federation	RU	RUS	RUB Russian ruble	7+ Moscow 495
Slovakia	SK	SVK	EUR Euro	421+ Bratislava 2
Spain	ES	ESP	EUR Euro	34+ Madrid 91
Sweden	SE	SWE	SEK Swedish krona	46+ Stockholm 8
Switzerland	CH	CHE	CHF Swiss franc	41+ Zurich 1
Tajikistan	TJ	TJK	TJS Somoni	992+ Dushanbe 372
Turkey	TR	TUR	TRL Turkish lira	90+ Ankara 312
Turkmenistan	TM	TKM	TMM Manat	993+ Ashkhabad 12
Ukraine	UA	UKR	UAH Hrivna	380+ Kiev 44
United Kingdom	GB	GBR	GBP Pound Sterling	44+ London 171
United States	US	USA	USD Dollar	1+ Washington 202
Uzbekistan	UZ	UZB	UZS Sum	998+ Tashkent 71

# DISTANCES IN KM

Zagreb	1520	1090	350	1300	350	2740	1600	2870	130	1660	2210	2220	1400	660	890	780	2210	1050	370	
Vienna	1760	640	60	1110	240	2020	1410	3090	380	1440	2440	1990	1240	290	1120	1030	2020	680		370
Warsaw	2200	590	650	1330	690	1860	890	3460	1060	1610	2900	1470	1600	610	1800	1470	1510		680	1050
Stockholm	3260	1010	1710	1520	2280	1800	620	3680	2120	1820	3120	530	1820	1380	2620	3000		1510	2020	2210
Sofia	830	1880	990	2090	780	3000	2380	3660	920	2420	3000	2970	2120	1320	1680		3000	1470	1030	780
Rome	780	1500	1180	1500	1360	2620	2010	2640	760	1810	1980	2590	1420	1300		1680	2620	1800	1120	
Prague	2050	350	330	920	530	1380	760	2890	670	1250	2330	1350	1050		1300	1320	1380	610	290	660
Paris	2070	1050	1310	310	1490	1820	1210	1850	1260	420	1300	1790		1050	1420	2120	1820	1600	1240	1400
Oslo	3230	980	1680	1490	2250	530	590	3650	2080	1780	3090		1790	1350	2590	2970	530	1470	1990	2220
Madrid	2740	2350	2500	1610	2680	3120	2510	620	2080	1720	3090	1300		2330	1980	3000	3120	2900	2440	2210
London	2450	1060	1520	3030	1700	1820	1200	2280	1530		1720	1780	420	1250	1810	2420	1820	1610	1440	1660
Ljubljana	1950	1000	440	1200	620	2120	1500	2730		1530	2080	2080	1260	670	760	920	2120	1060	380	130
Lisbon	3400	2910	3160	2170	3340	620	3070		2730	2280	620	3650	1850	2890	2640	3660	3680	3460	3090	2870
Copenhagen	2640	400	1090	900	1660	620		3070	1500	1200	2510	590	1210	760	2010	2380	620	890	1410	1600
Helsinki	3260	1010	1710	1520	2290		620	3680	2120	1820	3120	530	1820	1380	2620	3000	1800	1860	2020	2740
Budapest	1520	880	200	1370		2290		3340	620	1700	2680	2250	1490	530	1360	780	2280	690	240	350
Brussels	2130	770	1190		1370	1520	900	2170	1200	3030	1610	1490	310	920	1500	2090	1520	1330	1110	1300
Bratislava	1720	670		1190	200	1710	1090	3160	440	1520	2500	1680	1310	330	1180	990	1710	650	60	350
Berlin	2140		670	770	880	1010	400	2910	1000	1060	2350	980	1050	350	1500	1880	1010	590	640	1090
Athens		2140	1720	2130	1520	3260	2640	3400	1950	2450	2740	3230	2070	2050	780	830	3260	2200	1760	1520
Athens	Athens	Berlin	Bratislava	Brussels	Budapest	Helsinki	Copenhagen	Lisbon	Ljubljana	London	Madrid	Oslo	Paris	Prague	Rome	Sofia	Stockholm	Warsaw	Vienna	Zagreb

# TABLES OF METRIC WEIGHTS & MEASURES

LINEAR MEASURES		
10 millimeters (mm)	1 centimeter (cm)	
10 centimeters	1 decimeter (dm)	100 millimeters
10 decimeters	1 meter (m)	1,000 millimeters
10 meters	1 dekameter (dam)	
10 dekameters	1 hectometer (hm)	100 meters
10 hectometers	1 kilometer (km)	1,000 meters









VOLUME MEASURES		
10 milliliters (ml)	1 centiliter (cl)	
10 centiliters	1 deciliter (dl)	100 milliliters
10 deciliters	1 liter (l)	1,000 milliliters
10 liters	1 dekaliter (dal)	
10 dekaliters	1 hectoliter (h l)	100 liters
10 hectoliters	1 kiloliter (kl)	1,000 liters

AREA MEASURES		
100 square millimeters (mm <sup>2</sup> )	1 sq centimeter (cm <sup>2</sup> )	
10,000 square centimeters	1 sq meter (m <sup>2</sup> )	1,000,000 sq millimeters
100 square meters	1 are (a)	
100 ares	1 hectare (ha)	10,000 sq meters
100 hectares	1 sq kilometer (km <sup>2</sup> )	1,000,000 sq meters









CUBIC MEASURES		
1,000 cubic millimeters (mm <sup>3</sup> )	1 cu centimeter (cm <sup>3</sup> )	
1,000 cubic centimeters	1 cu decimeter (dm <sup>3</sup> )	1,000,000 cu millimeters
1,000 cubic decimeters	1 cu meter (m <sup>3</sup> )	
	1 stere	
	1,000,000 cu centimeters	
	1,000,000,000 cu millimeters	

WEIGHT		
10 milligrams (mg)	1 centigram (cg)	
10 centigrams	1 decigram (dg)	100 milligrams
10 decigrams	1 gram (g)	1,000 milligrams
10 grams	1 dekagram (dag)	
10 dekagrams	1 hectogram (hg)	100 grams
10 hectograms	1 kilogram (kg)	1,000 grams
1,000 kilograms	1 metric ton (t)	





## TYPES OF VEHICLES AND EQUIPMENT

Types of vehicles & trailers	Description	Length, m	Width, m	Height, m	Capacity, m <sup>3</sup>	Maximal cargo, t
 <p>Minivan</p>	Designed for transporting cargo with small weight and capacity.	3.0-5.3	2.0-2.4	1.8-2.4	3-10	1-3
 <p>Tilt or Curtain sided trailer</p>	Designed for transporting most kinds of cargo. Loadings and discharges are possible from the top, sides and from the back.	13.6	2.4-2.5	2.4-2.85	82-95 33 euro pallets	24
 <p>Mega trailer</p>	Similar to a Tilt/Curtain-sided trailer but with increased ceiling height.	13.6	2.4-2.5	2.87-3.00	96-105 33 euro pallets	24
 <p>Jumbo</p>	Trailer of increased capacity, due to the L-type stepframe floor and smaller wheels.	13.8	2.45	2.45-3.00	96 33 euro pallets	20-24
 <p>Road-train</p>	Comprises of a tractor vehicle and a trailer. Most suitable for large-volume, lightweight "volume goods".	15.6-16.0	2.4-2.5	2.9-3.05	110-120 38 euro pallets	12-20
 <p>Box trailer</p>	Trailer with hard sides along the full length and height of trailer. The sides of the body are never deformed and can work as a restraint for the cargo during transportation. Cargo can be loaded only from the back.	13.6	2.4-2.5	2.4-2.75	82-92 33 euro pallets	22
 <p>Thermo box or Isotherm trailer</p>	Heat-insulated trailer without refrigerating equipment. Designed for short distance transporting while maintaining cargo loading temperature. Inside temperature change is 1 degree per day. Loading only from the back.	13.6	2.4-2.5	2.4-2.75	82-92 33 euro pallets	22
 <p>Temperature controlled trailer / Frigo</p>	Similar to a Thermo box/Isotherm trailer but has a refrigerating equipment. Designed for transporting perishable cargo. The set temperature range of +25 C to -25 C can be constantly maintained. Loading only from the back.	13.6	2.4-2.5	2.4-2.75	60-92 32-33 euro pallets	20
 <p>Double Decker</p>	Similar to Frigo trailer but has 2 sections, where is possible to set 2 different temperature from +25 C to -25 C.	13.6	2.4-2.5	2.4-2.75	60-92 66 euro pallets	20





## TYPES OF VEHICLES AND EQUIPMENT

Types of vehicles & trailers	Description	Length, m	Width, m	Height, m	Capacity, m <sup>3</sup>	Maximal cargo, t
 <p>Grain hopper truck</p>	Designed for transporting grains.	13.6	2.55	-	45	25
 <p>Dump-body truck</p>	Designed for transporting sand and other bulk cargo.	11	2.55	-	45	26
 <p>Tank truck</p>	Heat-insulated tank or tank with refrigerating equipment. Designed for transporting liquids (food concentrates, chemical substances, oils, alcohol etc.).	13.6	2.4-2.5	2.5	25	25
 <p>Modular trailers (incl. dolly, SPMT, Vario etc.)</p>	Designed for transporting heavy and oversized cargo (wind blades, tubes).	13.6<+	2.5<+	-	depends on permit obtain	
 <p>Open platform trailers (teletrailer, telemega)</p>	Designed for transporting heavy and oversized cargo (wind blades, tubes).	13,6-55,0	2,5<+	-	depends on permit obtain	
 <p>Semi trailer</p>	Designed for transporting heavy and oversized cargo (building equipment, trafo, coustruction).	13.6-35,0	2.5<+	-	depends on permit obtain	
 <p>Low bed</p>	Designed for transporting heavy and oversized cargo (building equipment, yacht, high construction).	8-17,00	2.5<+	-	depends on permit obtain	
 <p>Automobile transporter</p>	Designed for transporting cars.	13.6	2.4-2.55	-	8-10 cars	20-25
 <p>Container chassis</p>	Designed for transporting different kinds of containers.	9	2.4	-	20/30/ 40/45 foot	24

## TYPES OF RAILWAY ROLLING - STOCK

Types of wagons	Description	Capacity, m <sup>3</sup>	Maximal cargo, t
<p>Covered wagons</p> 	Designed for transporting most kinds of cargo: general cargo, palletized goods, big bags, boxes, equipment and etc.	120-158	64-72
<p>Open wagons</p> 	Designed for transporting bulk goods: wood, stone, metal, heavy goods, equipment and etc.	72-75	69-71
<p>Covered wagons with metal walls</p> 	Wagon with hard sides along the full length and height. The sides are never deformed and can work as a restraint for the cargo during transportation. Designed for transporting general goods, vehicles: bus, truck and etc.	200-250	49-55
<p>Isothermal wagons</p> 	Heat-insulated wagon without refrigerating equipment. Designed for transporting general goods, perishable goods: beer, juices, beverages and other temperature-sensitive cargo, which do not need temperature control.	110-138, 44-50 euro pallets on the floor	47-53

## TYPES OF RAILWAY ROLLING - STOCK

Types of wagons	Description	Capacity, m <sup>3</sup>	Maximal cargo, t
<p>Refer wagons</p> 	Similar to Isotherm wagon but has a refrigerating equipment. Designed for transporting all types of perishable goods: frozen meat, fruits and vegetables, drinks and etc.	110-138, 44-48 euro pallets on the floor	42-49
<p>Wagon hopper</p> 	Designed for transporting loose cargo: grain, fertilizers and etc.	81	70
<p>Flat wagons universal</p> 	Designed for transporting heavy, lengthy, and oversized goods: metal, tubes, vehicles and etc.	Length 13,3-19,6-25,72 meters	70-73
<p>Car-carrying wagons</p> 	Designed for transporting cars.	8-12 cars	16-25
<p>Container platform</p> 	Designed for transporting different kinds of containers: Standard 20', Standard 40', High Cube 40', Open Top 40' and etc.	40-, 60-, 80- foot	72

# TYPES OF CONTAINERS

Types of containers		Length, m	Width, m	Height, m	Door width, m	Door height, m	Capacity, m³	Tare weight, kgs	Maximal cargo, kgs
	Standard 20'	5.89	2.350	2.392	2.342	2.280	33,2 11 euro pallets	2,230	24,850
	Standard 40'	12.036	2.35	2.392	2.340	2.280	67.7 23 euro pallets	3,700	28,860
	Upgraded 20'	5.9	2.311	2.390	2.286	2.280	32.63 11 euro pallets	2,300	28,180
	High Cube 40'	12.036	2.350	2.697	2.338	2.585	76.3 23 euro pallets	3,970	28,860
	Reefer 20'	5.45	2.29	2.160	2.29	2.22	28.3 10 euro pallets	2,930	27,500
	Reefer 40'	11.577	2.294	2.210	2.294	2.174	56.1 23 euro pallets	3,900	28,600
	High Cube Reefer 40'	11.59	2.29	2.400	2.29	2.57	67.9 23 euro pallets	4,500	30,260
	Open Top 20'	5.90	2.35	2.35	2.25	-	32.23 11 euro pallets	2,250	28,100
	Open Top 40'	12.028	2.350	2.350	2.341	2.274	66.5 23 euro pallets	3,800	26,680
	Flat Rack 20'	5.620	2.200	2.233	-	-	-	2,530	21,470
	Flat Rack 40'	12.080	2.438	2.103	-	-	-	5,480	39,000
	Flat Rack Collapsible 20'	5.96	2.4	2.29	-	-	-	2,970	37,000
	Flat Rack Collapsible 40'	11.65	2.37	1.96	-	-	-	5,200	44,650

# TYPES OF CONTAINERS

Types of containers		Length, m	Width, m	Height, m	Door width, m	Door height, m	Capacity, m³	Tare weight, kgs	Maximal cargo, kgs
	Platform 20'	6.058	2.438	2.233	-	-	-	2,750	24,000
	Platform 40'	12.18	2.40	1.95	-	-	-	5,800	39,200
	Pallet Wide 20'	5.92	2.44	2.38	2.39	2.26	34.6 14 euro pallets	On request	On request
	Pallet Wide 40'	12.03	2.42	2.38	2.39	2.28	70.1 30 euro pallets	On request	On request
	High Cube Wide 40'	12.05	2.42	2.68	2.39	2.58	79.1 30 euro pallets	On request	On request
	High Cube Wide 45'	13.54	2.42	2.69	2.40	2.58	88.7 33 euro pallets	On request	On request
	Easy Load 20'	5.9	2.43	2.45	2.40	2.33	35.1 14 euro pallets	On request	On request
	Easy Load 45'	13.55	2.45	2.45	2.43	2.34	81.9 33 euro pallets	On request	On request
	Heavy Load Box 20'	5.92	2.43	2.53	2.43	2.41	36.3 14 euro pallets	On request	On request
	High Cube Reefer 45'	13.11	2.44	2.56	2.40	2.58	82.1 32 euro pallets	On request	On request
	20ft Tank Container	36000	6.058	2.438	2.591	-	-	24	4200

# ULD'S SPECIFICATION

ULD	IATA	Dims	US/ATA	Payload (kg)	Volume (m³)	Type of A/C
Pallet	PMC	2 438 * 3 175 * 1 626 mm (80,4 * 125 * 64 in)	P6P	1800-2000	10,00	333, 332, 763
Pallet	PAG	2 235 * 3 175 * 1 626 mm (88 * 125 * 64 in)	P1P	1500-1700	9,00	333, 332, 763
Pallet	FLA	1 534 * 3 175 * 1 626 mm (88 * 125 * 64 in)	P9P	1000-1200	6,00	333, 332, IL9
Pallet	PKC	1 534 * 1 562 * 1 143 mm (60,4 * 61,5 * 45 in)	LD3-46P	500-600	2,70	319, 320, 321
Pallet	PGA	2 438 * 6 058 mm (96 * 238 in)		13100	34,3	MD-11F
Container	DPE	1 194 * 1 534 * 1 626 mm (47 * 60,4 * 64 in)	LD2	500-600	2,70	763
Container	AKE	1 534 * 1 562 * 1 626 mm (60,4 * 61,5 * 64 in)	LD3	700-800	3,70	333, 332, 763, IL9
Container	AKH	1 534 * 1 562 * 1 143 mm (60,4 * 61,5 * 45 in)	LD3-46W	500-600	2,70	319, 320, 321
Container	ALF	1 534 * 4 064 * 1 626 mm	LD6	3175	6,94	MD-11F

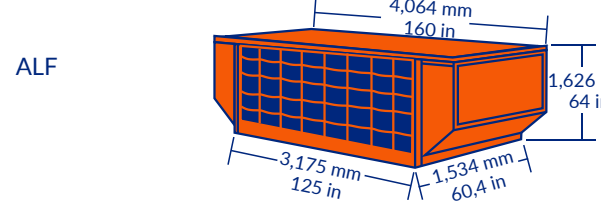
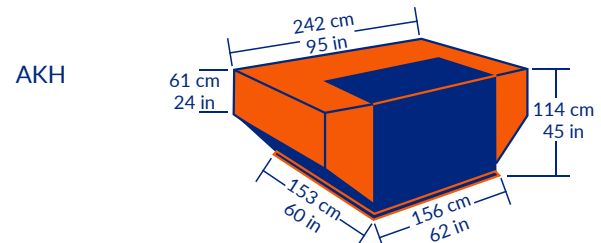
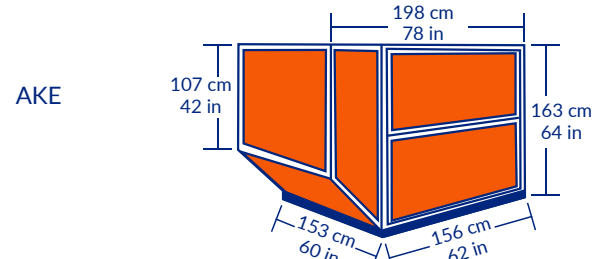
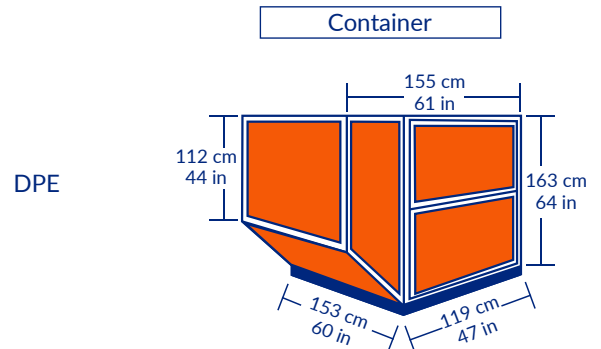
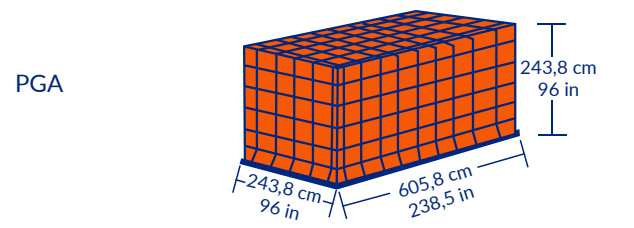
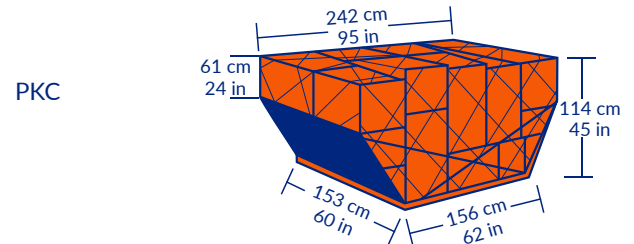
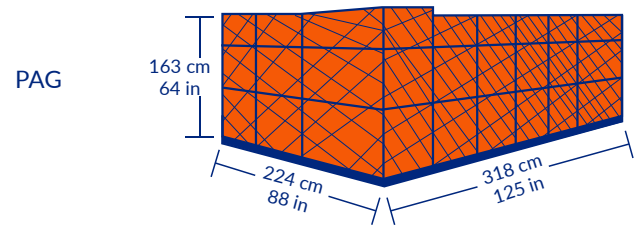
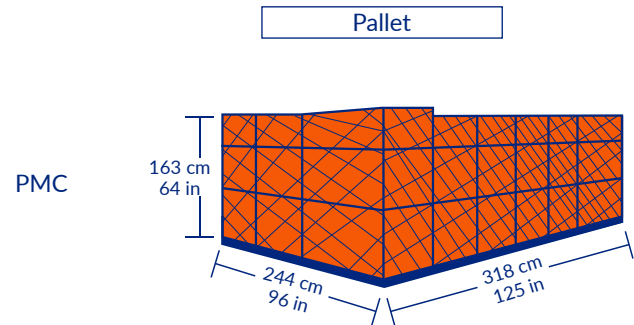

# HAZARD CLASSIFICATIONS (ADR)

## CLASS OF HAZARD

- 1
- 2
- 3
- 4.1
- 4.2
- 4.3
- 5.1
- 5.2
- 6.1
- 6.2
- 7
- 8
- 9

## GROUPS OF SUBSTANCES

- Explosive substances and articles
- Gases
- Flammable liquids
- Flammable Solids, self reactive substances and solid desensitized explosives
- Substances liable to spontaneous combustion
- Substances which, in contact with water, emit flammable gases
- Oxidizing substances
- Organic peroxides
- Toxic substances
- Infectious substances
- Radioactive substances
- Corrosive substances
- Miscellaneous dangerous substances and articles

# TYPES OF PALLETS

## EURO pallet type

- EUR, EUR1
- EUR2
- EUR3
- EUR6

## Dimensions, mm / in (W x L)

- 800 x 1,200 mm / 31.50 x 47.24 in
- 1,200 x 1,000 mm / 47.24 x 39.37 in
- 1,000 x 1,200 mm / 39.37 x 47.24 in
- 800 x 600 mm / 31.50 x 23.62 in
- 600 x 400 mm / 23.62 x 15.75 in
- 400 x 300 mm / 15.75 x 11.81 in

## ISO pallet alternative

- ISO1, same size as EUR
- ISO2
- ISO0, half the size of EUR
- quarter the size of EUR
- eighth the size of EUR

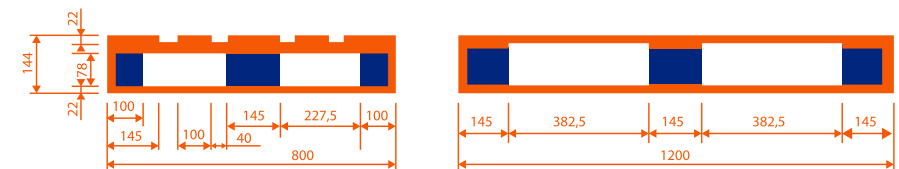

PALETTE EUR-EPAL ©

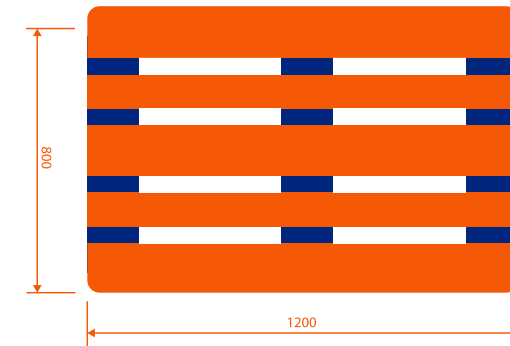



# CMR Consignment

1 Sender (name, address, country)		INTERNATIONAL CONSIGNMENT NOTE <b>CMR</b> This carriage is subject notwithstanding any clause to the contrary, to the Convention on the Contract for the International Carriage of goods by road (CMR)						
2 Consignee (name, address, country)		16 Carrier (name, address, country)						
3 Place of delivery of the goods (place, country)		17 Successive carriers (name, address, country)						
4 Place and date of taking over the goods (place, country, date)		18 Carrier's reservations and observations						
5 Documents attached								
6 Marks and numbers	7 Number of packages	8 Method of packing	9 Nature of the goods	10 Statistical number	11 Gross weight in kg	12 Volume in m <sup>3</sup>		
Class	Number	Letter	(ADR*)					
13 Sender's instructions			19 Special agreements					
14 Instruction as to payment for carriage <input type="checkbox"/> Carriage paid <input type="checkbox"/> Carriage forward			20 To be paid by					
			Carriage charges					
			Reductions					
			Balance					
			Supplem. charges					
			Miscellaneous					
21 Established in _____ on _____ 20__			15 Cash on delivery					
22		23		24 Goods received Place _____ on _____ 20__				
Signature and stamp of the sender		Signature and stamp of the carrier		Signature and stamp of the consignee				

The spaces framed with heavy lines must be filled in by the carrier

19 - 21 + 22 including and

1 - 15 To be completed on the sender's responsibility

In case of dangerous goods mention, besides the possible conditions, on the last line of the column the particulars of the class, the number and the letter "X" or "Y"

# AIR WAYBILL

Ahipper's name Address		Not Negotiable <b>Air Waybill</b> Issued by	
		Copies 1, 2 and 3 of this Air Waybill are have the same validity	
Consignee's name and Address		It is agreed that the goods described herein are accepted in apartment good order and condition (except as noted) for carriage SUBJECT TO THE CONDITIONS OF CONTRACT ON THE REVERSE HERE OF ALL GOODS MAY BE CARRIED BY ANY OTHER MEANS INCLUDING ROAD OR ANY OTHER CARRIER UNLESS SPECIFIC CONTRARY INSTRUCTIONS ARE GIVEN HEREON BY THE SHIPPER. THE SHIPPER'S ATTENTION IS DRAWN TO THE NOTICE CONCERNING CARRIER'S LIMITATION OF LIABILITY	
Issuing Carrier's Agent Name and City		Accounting INFORMATION	
Agent's IATA Code		Account No.	
Airport of Departure (Addr. Of First Carrier) and Requested Routing		<b>IATA</b>	
to	By Firs Carrier	to	by
Airport of destination	Flight/Date	Flight/Date	Amount of Insurance
			INSURANCE - If Carrier offers insurance and such insurance is requested in accordance with conditions on reverse hereof, indicate amount to be insured in figures in box marked „Amount of Insurance“
Handing Information			
No. of Pieces RCP	Gross Weight	kg lb	Rate Class Commodity Item No.
Prepaid Weight	Charge Collect	Other Charges	
Valuation	Charge		
Tax			
Total Other Charges Due Agenti	Shipper certifies that the particulars on the face hereof are correct and that insofar as any part of the consignment contains dangerous goods, such part is properly described by name and is in proper condition for carriage by air according to the applicable Dangerous Goods Regulations		
Total Other Charges Due Agenti			
Signature of Shipper or his Agent			
Total Pepaid	Total Collect		
Currency Conversion Rate	CC Charges in Destination Currency		
		Executed on (Date) _____ at (Place) _____ Signature of Issuing Carrier or its Agent	
For Carrier's Use only at Destination	Charges at Destination	Total Collect Charges	XXX-XXXX-XXXX

# Bill of Lading

1. Shipper		B/L NO.				
2. Consignee		<p align="center"><b>BILL OF LADING</b></p> <p>RECEIVED in external apparent good order and condition. Except otherwise noted, the total number of containers or other packages or units shown in this Bill of Lading receipt. Said by the shipper to contain the goods described above. Which description the carrier has no reasonable means of checking and is not part of the Bill of Lading. One original Bill of Lading should be surrendered, except clause 22 paragraph 5, in exchange for delivery of the shipment. Signed by the consigned or duly endorsed by the holder in due course.</p> <p>Whereupon the other original(s) issued shall be void. In accepting this Bill of Lading, The Merchants agree to be bound by all the terms on the face and back hereof as if each had personally signed this Bill of Lading.</p> <p>WHEN the Place of Receipt of the Goods an inland point and is so named herein, any notation of "ON BOARD", "SHIPPED ON BOARD" or words to like effect on this Bill of Lading shall be deemed to mean on board the truck, trail car, air craft or other inland conveyance (as the case may be), performing carriage from the Place of Receipt of the Goods to the Port of Loading.</p> <p>SEE clause 4 on the back of this Bill of Lading (Terms continued on the back hereof Read Carefully)</p>				
3. Notify Party(Carrier not to be responsible for failure to notify) SAME AS CONSIGNEE						
4. Pre-Carriage by	5. Place of Receipt:					
6. Ocean Vessel Voy.No.	7. Port of Loading					
8. Port of Discharge		9. Place of Delivery			10. Final Destination(of the goods-not the ship)	
11. Marks & Nos. Container Seal No.	12. No.of Containers or Pkgs	13. Kind of Packages:Description of Goods.		14. GrossWeight kgs	15. Measurement	
<p><b>COPY - NON NEGOTIABLE</b></p> <p align="center" style="font-size: 2em; opacity: 0.5;">SAMPLE</p>						
16. Description of Contents for Shipper's Use Only(CARRIER NOT RESPONSIBLE)						
17. TOTAL NO.CONTAINERS OR PACKAGES(IN WORDS)						
18. Freight & Charges	19. Revenue Tons	20. Rate	21. Per	22. Prepaid	23. Collect	
24. EX RATE:	25. Prepaid at	26. PAYABLE AT	27. PLACE AND DATE OF ISSUE			
	28. Total Prepaid in	29. No.of Original B/L	Signed for the Carrier.			
DATE	.....					

# FBL (Negotiable Fiata Multimodal Transport Bill of Lading)

Consignor		<b>FBL</b> <input type="checkbox"/> <b>CH</b> <input type="checkbox"/>		
		NEGOTIABLE FIATA .. MULTIMODAL TRANSPORT BILL OF LADING issued subject to UNCTAD/ICC Rules for Multimodal Transport Documents (ICC Publication 411).		
Consigned to order of				
Notify address				
		Place of receipt		
Ocean vessel	Port of loading			
Measurement	Place of delivery			
Marks and numbers	Number and kind of packages	Description of goods	Gross weight	Measurement
<p align="center" style="font-size: 2em; opacity: 0.5;">SAMPLE</p>				
according to the declaration of the consignor				
Declaration of Interest of the consignor in timely delivery (Clause 6.2.)		Declared value for ad valorem rate according to the declaration of the consignor (Clauses 7 and 8).		
The goods and instructions are accepted and dealt with subject to the Standard Conditions printed overleaf. Taken in charge in apparent good order and condition, unless otherwise noted herein, at the place of receipt for transport and delivery as mentioned above. One of these Multimodal Transport Bills of Lading must be surrendered duly endorsed in exchange for the goods. In Witness whereof the original Multimodal Transport Bills of Lading all of this tenor and date have been signed in the number stated below, one of which being accomplished the other(s) to be void.				
Freight amount		Freight payable at	Place and date of issue	
Cargo Insurance though the undersigned not covered Covered according to attached Policy		Number of Original FBLs	Stamp and Signature	
For delivery of goods please apply to:				

# FIATA FCR (Forwarders Certificate of Receipt)

Suppliers or Forwarders Principals		FIATA FCR		CH	
Consignee		Forwarders Certificate of Receipt		ORIGINAL Forw. Ref.	
Marks and numbers	Number and kind of packages	Description of goods	Gross weight	Measurement	
					
according to the declaration of the consignor					
For the issuance of this FIATA FCR the issuers' liability is solely limited in compliance with art. 2, paragraph 5, in connection with art. 26 of the General Conditions of SPEDLOGSWISS - Swiss Freight Forwarding and Logistics Association printed overleaf, whereby loss of or damage to the goods shall be excluded.			* Forwarding instructions can only be cancelled or altered if the original Certificate is surrendered to us, and then only provided we are still in a position to comply with such cancellation or alteration.		
We certify having assumed control of the above mentioned consignment in external apparent good order and condition			at the disposal of the consignee		
with irrevocable instructions*			Instructions authorizing disposal by a third party can only be cancelled or altered if the original Certificate of Receipt is surrendered to us, and then only provided we have not yet received instructions under the original authority.		
Remarks			Place and date of issue		
Instructions as to freight and charges			Stamp and signature		

# SMGS Railway Bill

Дорожная ведомость (дополнительный экземпляр)  
Codała (egzemplarz dodatkowy)

29 Отправка № / Zestawienie №

1 Отправитель / Wysławca	2 Станция отправления / Stacja nadania	3 Значения отправителя / Oznaczenia nadawcy
4 Получатель / Odbiorca	5 Станция назначения / Stacja przeznaczenia	6 Перечисление станций назначения / Wykazanie miejsc przeznaczenia
7 Весы / Wagi	8 Масса груза / Masa ładunku	9 Масса тары / Masa ładunku
10 Масса нетто / Masa czysta	11 Масса брутто / Masa brutto	12 Тип вагона / Typ wagonu
13 Масса (в кг) / Masa (w kg)	14 Масса (в кг) / Masa (w kg)	15 Масса (в кг) / Masa (w kg)
16 Вид упаковки / Rodzaj opakowania	17 К-во мест / Liczba sztuk	18 Масса (в кг) / Masa (w kg)
19 Упаковка / Pakowanie	20 Упаковка / Pakowanie	21 Упаковка / Pakowanie
22 Перевозчик / Przewoźnik	23 Перевозчик / Przewoźnik	24 Перевозчик / Przewoźnik
25 Уникальные данные / Unikalne dane	26 Уникальные данные / Unikalne dane	27 Уникальные данные / Unikalne dane
28 Документы, прилагаемые к перевозке / Dokumenty dołączone do przewozu	29 Документы, прилагаемые к перевозке / Dokumenty dołączone do przewozu	30 Документы, прилагаемые к перевозке / Dokumenty dołączone do przewozu
31 Дата заполнения документа перевозкой / Data wypełnienia dokumentu przewozowego	32 Дата прибытия / Data przybycia	33 Дата прибытия / Data przybycia
34 Отметка для вычисления таможенных и других административных формальностей / Uwaga w celu wyliczenia celnych i innych administracyjnych formalności	35 Отметка для вычисления таможенных и других административных формальностей / Uwaga w celu wyliczenia celnych i innych administracyjnych formalności	36 Отметка для вычисления таможенных и других административных формальностей / Uwaga w celu wyliczenia celnych i innych administracyjnych formalności

Разделы по расчету провозных платежей

A	17 Расчет	18 Расчет	19 Расчет	20 Расчет	21 Расчет	22 Расчет	23 Расчет	24 Расчет	25 Расчет	26 Расчет	27 Расчет
B	28 Расчет	29 Расчет	30 Расчет	31 Расчет	32 Расчет	33 Расчет	34 Расчет	35 Расчет	36 Расчет	37 Расчет	38 Расчет
C	39 Расчет	40 Расчет	41 Расчет	42 Расчет	43 Расчет	44 Расчет	45 Расчет	46 Расчет	47 Расчет	48 Расчет	49 Расчет
D	50 Расчет	51 Расчет	52 Расчет	53 Расчет	54 Расчет	55 Расчет	56 Расчет	57 Расчет	58 Расчет	59 Расчет	60 Расчет

# CIM Railway Bill

**List przewozowy CIM / Frachtbrief CIM**

**List wagonowy CUV / Wagonbrief CUV**

**1**

Original

PDF S.A. 2739-104-21 (04-1134) Warszawa 010

**CaSUI - Frachtkarte**

**2**

**Ośrodek obsługiwany (kraj działy) - Frachtkarte (Fortsetzung)**

Stacja / Station	Typ	Przebieg / Durchlauf	Ważność / Gültigkeit	Uwagi / Bemerkungen
1	...	...	...	...
2	...	...	...	...
3	...	...	...	...
4	...	...	...	...
5	...	...	...	...
6	...	...	...	...
7	...	...	...	...
8	...	...	...	...
9	...	...	...	...
10	...	...	...	...
11	...	...	...	...
12	...	...	...	...
13	...	...	...	...
14	...	...	...	...
15	...	...	...	...
16	...	...	...	...
17	...	...	...	...
18	...	...	...	...
19	...	...	...	...
20	...	...	...	...
21	...	...	...	...
22	...	...	...	...
23	...	...	...	...
24	...	...	...	...
25	...	...	...	...
26	...	...	...	...
27	...	...	...	...
28	...	...	...	...
29	...	...	...	...
30	...	...	...	...
31	...	...	...	...
32	...	...	...	...
33	...	...	...	...
34	...	...	...	...
35	...	...	...	...
36	...	...	...	...
37	...	...	...	...
38	...	...	...	...
39	...	...	...	...
40	...	...	...	...
41	...	...	...	...
42	...	...	...	...
43	...	...	...	...
44	...	...	...	...
45	...	...	...	...
46	...	...	...	...
47	...	...	...	...
48	...	...	...	...
49	...	...	...	...
50	...	...	...	...
51	...	...	...	...
52	...	...	...	...
53	...	...	...	...
54	...	...	...	...
55	...	...	...	...
56	...	...	...	...
57	...	...	...	...
58	...	...	...	...
59	...	...	...	...
60	...	...	...	...
61	...	...	...	...
62	...	...	...	...
63	...	...	...	...
64	...	...	...	...
65	...	...	...	...
66	...	...	...	...
67	...	...	...	...
68	...	...	...	...
69	...	...	...	...
70	...	...	...	...
71	...	...	...	...
72	...	...	...	...
73	...	...	...	...
74	...	...	...	...
75	...	...	...	...
76	...	...	...	...
77	...	...	...	...
78	...	...	...	...
79	...	...	...	...
80	...	...	...	...
81	...	...	...	...
82	...	...	...	...
83	...	...	...	...
84	...	...	...	...
85	...	...	...	...
86	...	...	...	...
87	...	...	...	...
88	...	...	...	...
89	...	...	...	...
90	...	...	...	...
91	...	...	...	...
92	...	...	...	...
93	...	...	...	...
94	...	...	...	...
95	...	...	...	...
96	...	...	...	...
97	...	...	...	...
98	...	...	...	...
99	...	...	...	...
100	...	...	...	...
101	...	...	...	...
102	...	...	...	...
103	...	...	...	...
104	...	...	...	...
105	...	...	...	...
106	...	...	...	...
107	...	...	...	...
108	...	...	...	...
109	...	...	...	...
110	...	...	...	...
111	...	...	...	...
112	...	...	...	...
113	...	...	...	...
114	...	...	...	...
115	...	...	...	...
116	...	...	...	...
117	...	...	...	...
118	...	...	...	...
119	...	...	...	...
120	...	...	...	...

# CIM SMGS Railway Bill

**Накладная CIM/CMGS / Frachtbrief CIM/SMGS**

**1**

Original

PDF S.A. 2739-104-21 (04-1134) Warszawa 010

**73** Сообщение - Verkehr

**74** Промышленная зона / Industrielle Zone

**75** Промышленная зона / Industrielle Zone

**76** Промышленная зона / Industrielle Zone

**77** Промышленная зона / Industrielle Zone

**78** Промышленная зона / Industrielle Zone

**79** Промышленная зона / Industrielle Zone

**80** Наименование груза / Bezeichnung des Gutes

**81** Место перемещения / Verschiebungsort

**82** Место назначения / Bestimmungsstation

**83** Место назначения / Bestimmungsstation

**84** Место назначения / Bestimmungsstation

**85** Место назначения / Bestimmungsstation

**86** Место назначения / Bestimmungsstation

**87** Место назначения / Bestimmungsstation

**88** Место назначения / Bestimmungsstation

**89** Место назначения / Bestimmungsstation

**90** Место назначения / Bestimmungsstation

**91** Место назначения / Bestimmungsstation

**92** Место назначения / Bestimmungsstation

**93** Место назначения / Bestimmungsstation

**94** Место назначения / Bestimmungsstation

**95** Место назначения / Bestimmungsstation

**96** Место назначения / Bestimmungsstation

**97** Место назначения / Bestimmungsstation

**98** Место назначения / Bestimmungsstation

**99** Место назначения / Bestimmungsstation

**100** Место назначения / Bestimmungsstation

**101** Место назначения / Bestimmungsstation

**102** Место назначения / Bestimmungsstation

**103** Место назначения / Bestimmungsstation

**104** Место назначения / Bestimmungsstation

**105** Место назначения / Bestimmungsstation

**106** Место назначения / Bestimmungsstation

**107** Место назначения / Bestimmungsstation

**108** Место назначения / Bestimmungsstation

**109** Место назначения / Bestimmungsstation

**110** Место назначения / Bestimmungsstation

**111** Место назначения / Bestimmungsstation

**112** Место назначения / Bestimmungsstation

**113** Место назначения / Bestimmungsstation

**114** Место назначения / Bestimmungsstation

**115** Место назначения / Bestimmungsstation

**116** Место назначения / Bestimmungsstation

**117** Место назначения / Bestimmungsstation

**118** Место назначения / Bestimmungsstation

**119** Место назначения / Bestimmungsstation

**120** Место назначения / Bestimmungsstation

Original

PDF S.A. 2739-104-21 (04-1134) Warszawa 010

# Carnet TIR



**IRU** International Road Transport Union

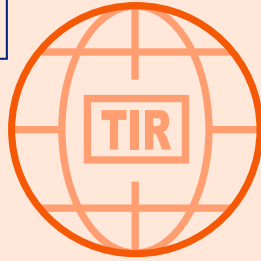

## CARNET TIR \*

### 6 volets

1. Valid for the acceptance of goods by the Customs office of departure up to and including

.....

2. Issued by .....

(name of issuing association)

3. Holder .....

(identification number, name, address, country)

4. Signature of authorized official of the issuing association and stamp of that association: .....

5. Signature of the secretary of the international organization: .....

To be completed before use by the holder of the carnet

6. Country/Countries of departure (1)

.....

7. Country/Countries of destination (1)

.....

8. Registration No(s), of road vehicle(s) <sup>(1)</sup>

.....

9. Certificate(s) of approval of road vehicle(s) (No. and date) <sup>(1)</sup>

.....

10. Identification No(s), of container(s) (1)

.....

11. Remarks .....

.....

<sup>(1)</sup> Strike out whichever does not apply

12. Signature of the carnet holder: .....

\* See annex 1 of the TIR Convention, 1975, prepared under the auspices of the United Nations Economic Commission for Europe.

# Carnet ATA

**A.T.A CARNET FOR TEMPORARY ADMISSION OF GOODS** INTERNATIONAL GUARANTEE CHAIN

CUSTOMS CONVENTION ON THE A.T.A. CARNET FOR THE TEMPORARY ADMISSION OF GOODS

CONVENTION ON TEMPORARY ADMISSION /

(Before completing the Carnet, please read Notes on cover page 3)

A T A  C A R N E T	A. HOLDER AND ADDRESS	G. FOR ISSUING ASSOCIATION USE																																																															
	B. REPRESENTED BY*	FRONT COVER																																																															
		a) CARNET No. <input style="width: 100%;" type="text"/>																																																															
C. INTENDED USE OF GOODS	b) ISSUED BY	c) VALID UNTIL																																																															
		..... / ..... / ..... year month day (inclusive)																																																															
P. This carnet may be used in the following countries/Customs territories under the guarantee of the associations listed on page four of the cover:																																																																	
<table style="width: 100%; border: none;"> <tr> <td style="width: 33%;">ALGERIA (DZ)</td> <td style="width: 33%;">ICELAND (IS)</td> <td style="width: 33%;">POLAND (PL)</td> </tr> <tr> <td>ANDORRE (AD)</td> <td>INDIA (IN)</td> <td>PORTUGAL (PT)</td> </tr> <tr> <td>AUSTRALIA (AU)</td> <td>IRELAND (IE)</td> <td>ROMANIA (RO)</td> </tr> <tr> <td>AUSTRIA (AT)</td> <td>ISRAEL (IL)</td> <td>RUSSIA (RU)</td> </tr> <tr> <td>BELARUS (BY)</td> <td>ITALY (IT)</td> <td>SENEGAL (SN)</td> </tr> <tr> <td>BELGIUM/LUXEMBOURG (BE)</td> <td>IVORY COAST (CI)</td> <td>SERBIA (CS)</td> </tr> <tr> <td>BULGARIA (BG)</td> <td>JAPAN (JP)</td> <td>SINGAPORE (SG)</td> </tr> <tr> <td>CANADA (CA)</td> <td>KOREA (REP.OF) (KR)</td> <td>SLOVAK REPUBLIC (SK)</td> </tr> <tr> <td>CHINA (CN)</td> <td>LATVIA (LV)</td> <td>SLOVENIA (SI)</td> </tr> <tr> <td>CROATIA (HR)</td> <td>LEBANON (LB)</td> <td>REPUBLIC OF SOUTH AFRICA (ZA)</td> </tr> <tr> <td>CYPRUS (CY)</td> <td>LITHUANIA (LT)</td> <td>SPAIN (ES)</td> </tr> <tr> <td>CZECH REPUBLIC (CZ)</td> <td>FORMER YUGOSLAV</td> <td>SRI LANKA (LK)</td> </tr> <tr> <td>DENMARK (DK)</td> <td>REPUBLIC OF MACEDONIA (MK)</td> <td>SWEDEN (SE)</td> </tr> <tr> <td>ESTONIA (EE)</td> <td>MALAYSIA (MY)</td> <td>SWITZERLAND (CH)</td> </tr> <tr> <td>FINLAND (FI)</td> <td>MALTA (MT)</td> <td>THAILAND (TH)</td> </tr> <tr> <td>FRANCE (FR)</td> <td>MAURITIUS (MU)</td> <td>TUNISIA (TN)</td> </tr> <tr> <td>GERMANY (DE)</td> <td>MONGOLIA (MN)</td> <td>TURKEY (TR)</td> </tr> <tr> <td>GIBRALTAR (GI)</td> <td>MOROCCO (MA)</td> <td>UKRAINE (UA)</td> </tr> <tr> <td>GREECE (GR)</td> <td>NETHERLANDS (NL)</td> <td>UNITED KINGDOM (GB)</td> </tr> <tr> <td>HONG KONG, CHINA (HK)</td> <td>NEW ZELAND (NZ)</td> <td>UNITED STATES (US)</td> </tr> <tr> <td>HUNGARY (HU)</td> <td>NORWAY (NO)</td> <td></td> </tr> </table>			ALGERIA (DZ)	ICELAND (IS)	POLAND (PL)	ANDORRE (AD)	INDIA (IN)	PORTUGAL (PT)	AUSTRALIA (AU)	IRELAND (IE)	ROMANIA (RO)	AUSTRIA (AT)	ISRAEL (IL)	RUSSIA (RU)	BELARUS (BY)	ITALY (IT)	SENEGAL (SN)	BELGIUM/LUXEMBOURG (BE)	IVORY COAST (CI)	SERBIA (CS)	BULGARIA (BG)	JAPAN (JP)	SINGAPORE (SG)	CANADA (CA)	KOREA (REP.OF) (KR)	SLOVAK REPUBLIC (SK)	CHINA (CN)	LATVIA (LV)	SLOVENIA (SI)	CROATIA (HR)	LEBANON (LB)	REPUBLIC OF SOUTH AFRICA (ZA)	CYPRUS (CY)	LITHUANIA (LT)	SPAIN (ES)	CZECH REPUBLIC (CZ)	FORMER YUGOSLAV	SRI LANKA (LK)	DENMARK (DK)	REPUBLIC OF MACEDONIA (MK)	SWEDEN (SE)	ESTONIA (EE)	MALAYSIA (MY)	SWITZERLAND (CH)	FINLAND (FI)	MALTA (MT)	THAILAND (TH)	FRANCE (FR)	MAURITIUS (MU)	TUNISIA (TN)	GERMANY (DE)	MONGOLIA (MN)	TURKEY (TR)	GIBRALTAR (GI)	MOROCCO (MA)	UKRAINE (UA)	GREECE (GR)	NETHERLANDS (NL)	UNITED KINGDOM (GB)	HONG KONG, CHINA (HK)	NEW ZELAND (NZ)	UNITED STATES (US)	HUNGARY (HU)	NORWAY (NO)	
ALGERIA (DZ)	ICELAND (IS)	POLAND (PL)																																																															
ANDORRE (AD)	INDIA (IN)	PORTUGAL (PT)																																																															
AUSTRALIA (AU)	IRELAND (IE)	ROMANIA (RO)																																																															
AUSTRIA (AT)	ISRAEL (IL)	RUSSIA (RU)																																																															
BELARUS (BY)	ITALY (IT)	SENEGAL (SN)																																																															
BELGIUM/LUXEMBOURG (BE)	IVORY COAST (CI)	SERBIA (CS)																																																															
BULGARIA (BG)	JAPAN (JP)	SINGAPORE (SG)																																																															
CANADA (CA)	KOREA (REP.OF) (KR)	SLOVAK REPUBLIC (SK)																																																															
CHINA (CN)	LATVIA (LV)	SLOVENIA (SI)																																																															
CROATIA (HR)	LEBANON (LB)	REPUBLIC OF SOUTH AFRICA (ZA)																																																															
CYPRUS (CY)	LITHUANIA (LT)	SPAIN (ES)																																																															
CZECH REPUBLIC (CZ)	FORMER YUGOSLAV	SRI LANKA (LK)																																																															
DENMARK (DK)	REPUBLIC OF MACEDONIA (MK)	SWEDEN (SE)																																																															
ESTONIA (EE)	MALAYSIA (MY)	SWITZERLAND (CH)																																																															
FINLAND (FI)	MALTA (MT)	THAILAND (TH)																																																															
FRANCE (FR)	MAURITIUS (MU)	TUNISIA (TN)																																																															
GERMANY (DE)	MONGOLIA (MN)	TURKEY (TR)																																																															
GIBRALTAR (GI)	MOROCCO (MA)	UKRAINE (UA)																																																															
GREECE (GR)	NETHERLANDS (NL)	UNITED KINGDOM (GB)																																																															
HONG KONG, CHINA (HK)	NEW ZELAND (NZ)	UNITED STATES (US)																																																															
HUNGARY (HU)	NORWAY (NO)																																																																
The holder of this Carnet and his representative will be held responsible for compliance with the laws and regulations of the country / Customs territory of departure and the countries / Customs territories of importation.																																																																	
H. CERTIFICATE BY CUSTOMS AT DEPARTURE  a) Identification marks have been affixed as indicated in column 7 against the following items No(s), at the General List  b) GOODS EXEMINED + Yes          No  c) Registered under Reference no. + /  d) ..... / ..... / ..... Customs Office Place          Date (year/month/day)          Signature and Stamp		I. Signature of authorised official and issuing Association stamp  ..... / ..... / ..... Place and Date          (year/month/day)  J.  ..... X Signature of Holder																																																															

\* If applicable